

Reversing FX120R-WD



ECE certified (ECE R23)
No registration in the car documents required



45° beam angle
Widely spread light beam

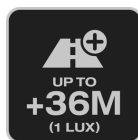

Up to 36 m long light beam
See and be seen with OSRAM



On-road & Off-road
- Versatile applicable and flexible in use- On-road & off-road, at work and in the spare time



Bringing light to life with OSRAM LEDriving driving and working lights

Considerable foresight on dark country roads, forest paths off-road and on-road- this can be achieved with the OSRAM LEDriving Reversing FX120R-WD reversing lights. With its 14 powerful, high-performance LEDs, the LED reversing light has a range of up to 36 meters and thus offers the driver impressive foresight on-road and off-road. Even in dim light and reduced visibility due to external environmental influences, the OSRAM LEDriving Reversing FX120R-WD reversing light with up to 6000 Kelvin can provide conditions similar to daylight. The powerpackage with up to 1100 lumens of luminosity scores with highest optical efficiency and homogeneous light distribution. This results in the possibility of an improved view for you and the improved visibility of your vehicle by other road users, and consequently also increased safety on-road and off-road. Whether on-road or off-road - the OSRAM LEDriving Reversing FX120R-WD reversing light impresses with its powerful performance and long service life. Versatile applicable, it defies numerous environmental influences and, thanks to high-quality materials such as the thermoplastic housing and the stable polycarbonate lens, it is particularly light and at the same time robust and resistant. The LEDdriving FX120R-WD reversing light has been tested and validated with the IP-Protection Class IP69K in our DIN certified environmental simulation laboratory for extreme external influences regarding water, dust, impacts, heat, cold and permanent vibration. The integrated driver and the thermal management system regulate the temperature of the LED reversing light and can thus prevent damage from overheating. The polarity protection inhibits the wrong polarity of the voltage supply and can thus prevent possible damage by automatically switching off the LEDs. On-road and off-road, the OSRAM LEDriving Reversing FX120R-WD reversing light is an effective addition to your vehicle. No registration or entry in the vehicle documents is necessary for these ECE-certified LED reversing lights. The LED reversing light can be attached to cars, trucks, agricultural machinery, farm machinery, commercial vehicles, construction vehicles, caravans, off-road vehicles and quads. The OSRAM LEDriving Reversing FX120R-WD reversing lights are versatile applicable and flexible in use.

Product datasheet

Technical data

Product information

Application (Category and Product specific)	Additional reversing light
---	----------------------------

General Product Information

Global order reference	LEDDL108-WD
------------------------	-------------

Electrical Data

Nominal voltage	12/24 V
Nominal wattage	15 W
Test voltage	13.2 V

Photometric Data

Nominal luminous flux	1100 lm
Color temperature	6000 K

Physical Attributes & Dimensions

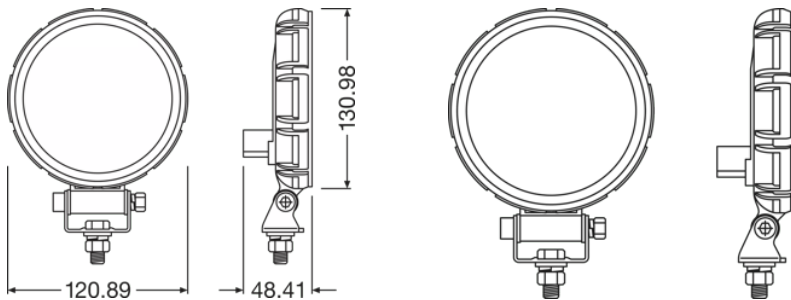

Product weight	360.00 g
Length	122.0 mm
Width	48.0 mm
Height	150.0 mm

Lifetime Data

Lifespan Tc	5000 hr
Guarantee	5 years

Additional product data

Connector to lamp	DT Connector
-------------------	--------------

Product datasheet

Capabilities

Technology	LED
------------	-----

Certificates & standards

Approval marks – approval	E9 approval
Type of protection	IP69K
Standards	ECE R10, R23

Logistical data

Commodity code	85122000900
----------------	-------------

Environmental & Regulatory Information

Information according Art. 33 of EU Regulation (EC) 1907/2006 (REACH)	
Date of declaration	28-10-2024
Candidate list substance 1	Lead
CAS No. of substance 1	7439-92-1
Safe use instruction	The identification of the Candidate List substance is sufficient to allow safe use of the article.
Declaration no. in SCIP database	8936bd98-dfb9-4240-8277-bca6fbc6e1d7

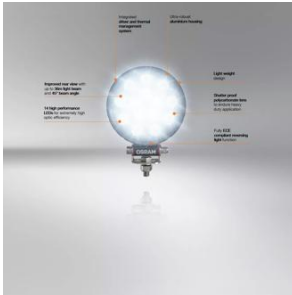

ref_pim_amsproductinfographics

Logistical Data











Product code	Product description	Packaging unit (Pieces/Unit)	Dimensions (length x width x height)	Volume	Gross weight
4062172105712	Reversing FX120R-WD	Folding carton box 1	132 mm x 72 mm x 152 mm	1.45 dm ³	407.00 g

Product datasheet

4062172105729	Reversing FX120R-WD	Shipping carton box 8	305 mm x 280 mm x 175 mm	14.95 dm ³	4080.00 g
---------------	---------------------	--------------------------	-----------------------------	-----------------------	-----------

The mentioned product code describes the smallest quantity unit which can be ordered. One shipping unit can contain one or more single products. When placing an order, for the quantity please enter single or multiples of a shipping unit.

Download Data

File	
	User instruction LEDriving
	Movie application LEDriving D and W Image Video Bringing light to life (EN)
	Movie application Working and Driving Lights Amarak Winter
	Movie application LEDriving Driving and Working Lights Reference Video (EN)
	Movie application OSRAM LEDdriving and working lights Imagefilm (EN)
	Movie application OSRAM Quality Testing LEDriving working and driving lights (EN)
	Video Light is Quality -OSRAM LEDriving Driving and Working Lights Quality Tests (EN)
	Video OSRAM LEDriving driving and working lights: The night doesn't stand a chance
	Video OSRAM LEDriving driving and working lights in action - From on road to off road applications (EN)
	Video Reference Number made easy - Making sure your LEDriving Driving Lights are legal on public roads
	ref_pim_amsproduct360degreeimages OSRAM LEDriving Reversing FX120R-WD

Legal advice

2) Special mounting regulations apply1) Precise terms and conditions at: www.osram.com/am-guarantee

Application advice

For more detailed application information and graphics please see product datasheet.

Disclaimer

Subject to change without notice. Errors and omission excepted. Always make sure to use the most recent release.



